

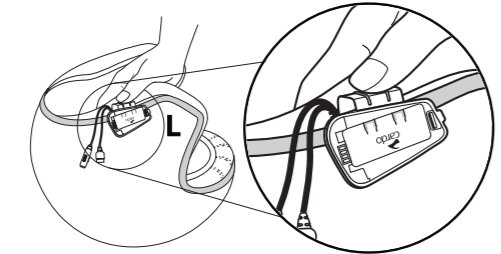

Option 1

Installation on narrow rim helmet
 Montage an schmalem Helm
 Installation sur casque à bord étroit
 Installazione su casco con bordo stretto
 Instalación en el casco de borde estrecho
 縁が狭いヘルメットへの取り付け
 安装于窄边头盔上

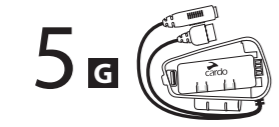
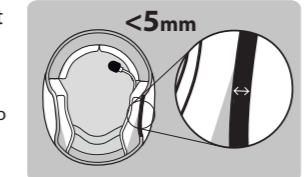

Push clamp into place
 Klemme einschieben
 Mettez l'attache en place
 Spingi l'aletta nella posizione corretta
 Empuja la abrazadera hasta que calce
 クランプを所定の位置に押し込む
 将夹钳推入就位

Option 2

Installation on wide rim helmet
 Montage an breitem Helm
 Installation sur casque à bord large
 Installazione su casco con bordo largo
 Instalación en el casco de borde ancho
 縁が広いヘルメットへの取り付け
 安装于宽边头盔上

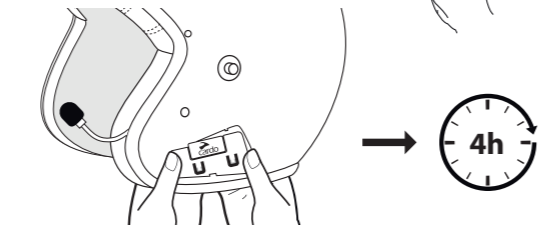
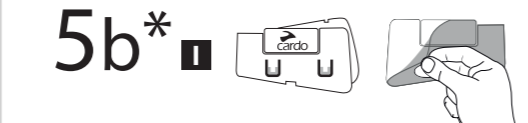
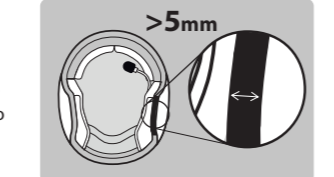

5c*

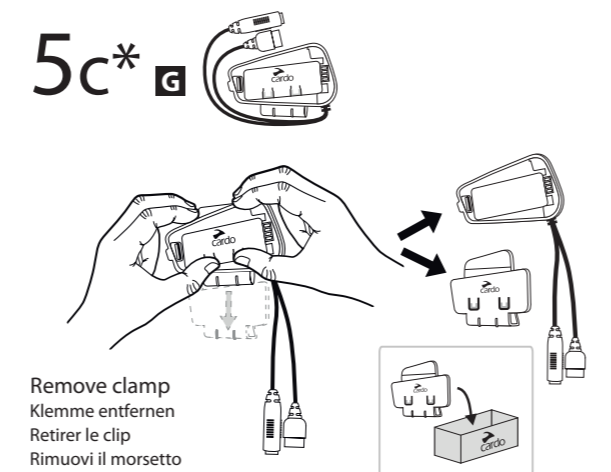

Remove clamp
 Klemme entfernen
 Retirer le clip
 Rimuovi il morsetto
 Quitar la abrazadera
 クランプを取り外す
 取下夹子

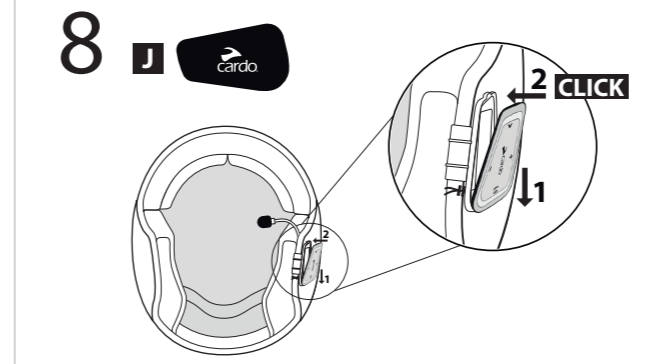
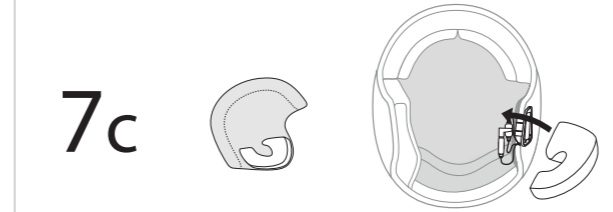
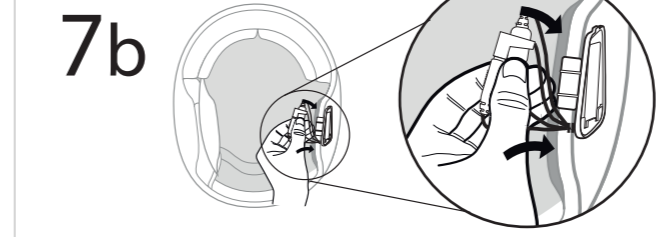
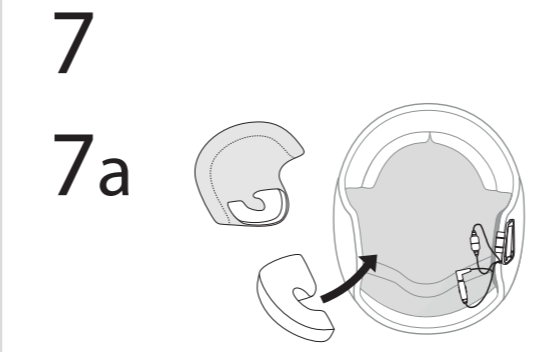
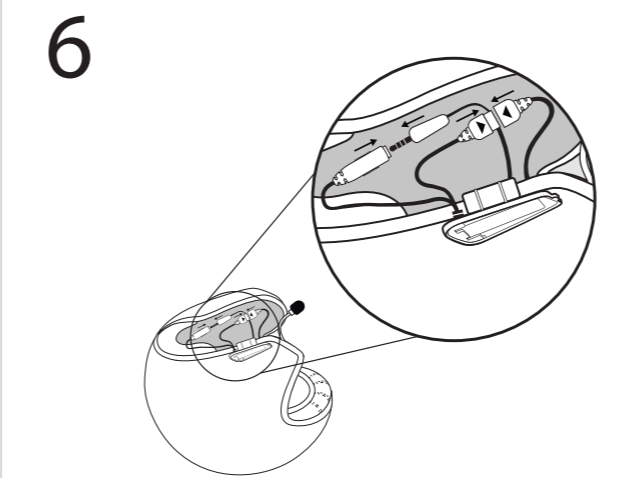
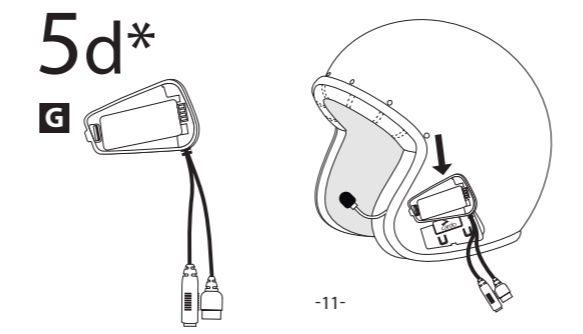

9 Optional x2

If needed, use booster pads to place speakers closer to ear
 Bei Bedarf Booster-Pads verwenden, um die Lautsprecher näher am Ohr zu platzieren
 Si nécessaire, utilisez des coussinets de rattrapage pour rapprocher les haut-parleurs de l'oreille
 Se necessario, utilizzare i cuscinetti per posizionare gli altoparlanti più vicino all'orecchio
 Si es necesario, use almohadillas de amplificadores para poner los altavoces cerca de la oreja
 必要に応じて、ブースターパッドを使ってスピーカーを耳に近づけます
 如果需要，请使用增强垫将耳机放置在更靠近耳朵的地方

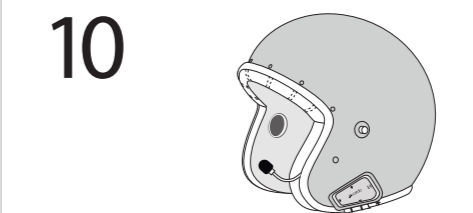
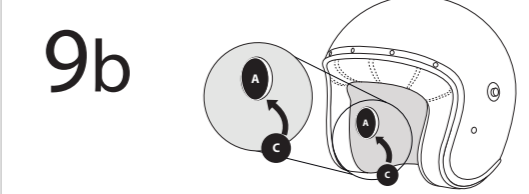
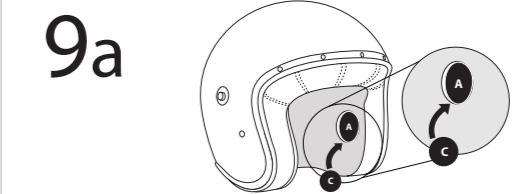

INSTALLATION VIDEO

Installationsvideo
Vidéo d'installation
Video d'installazione



Sold separately
Separat erhältlich
Vendu séparément
Venduto separatamente
Vendido por separado
別売り
单独出售

CONTENTS

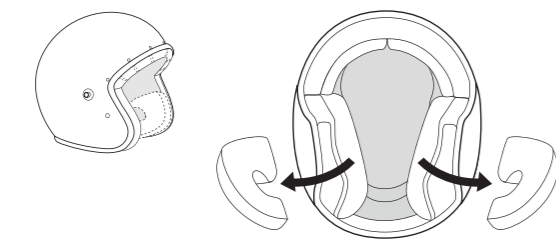
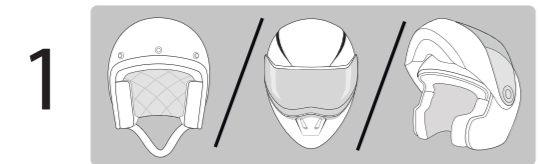
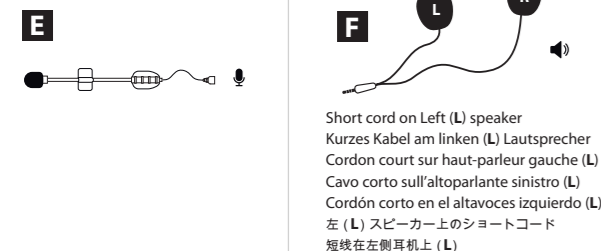

2 **A** x2

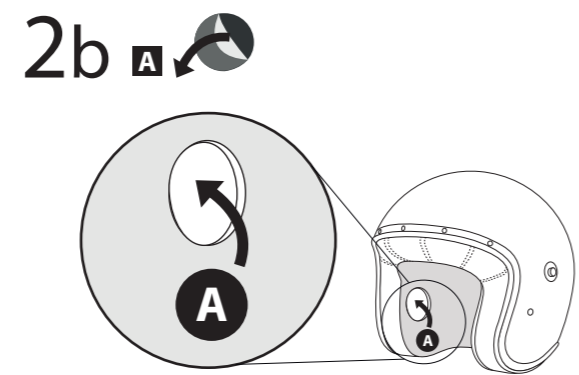
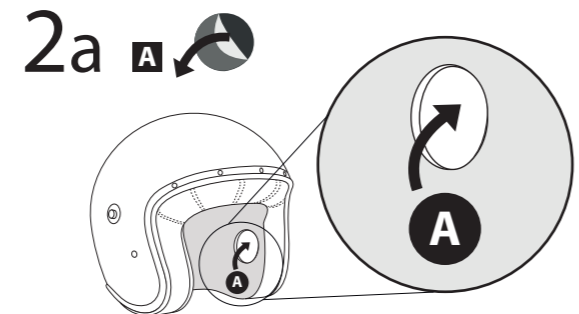

3 **F** **L** **R**

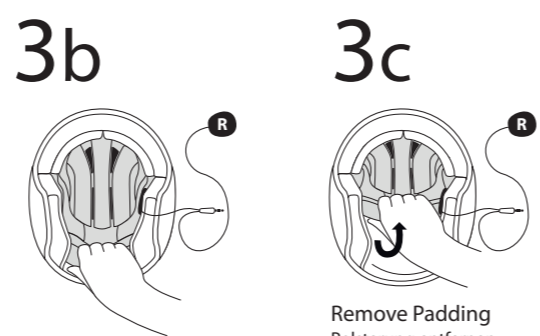
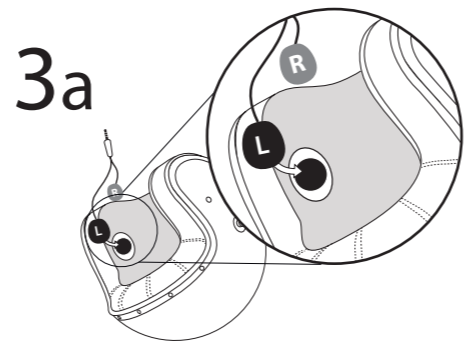

3d

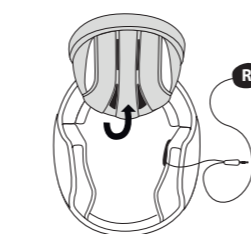

3e

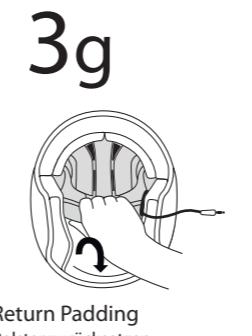
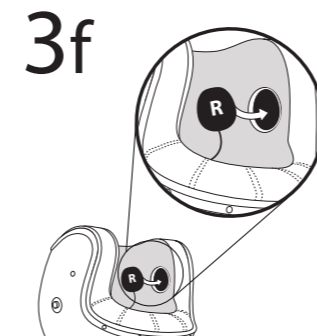
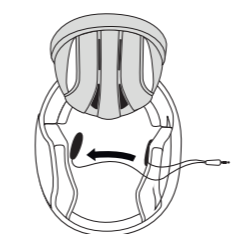

Option 1

Open face helmet installation
Installation an offenem Helm
Installation sur casque jet (open face)
Installazione su casco aperto
Instalación del casco abierto
オープンフェイスヘルメットへの取り付け
敞开式头盔安装

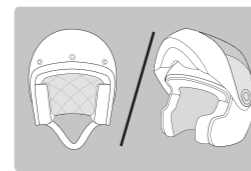

4 **B** x2 + **E**

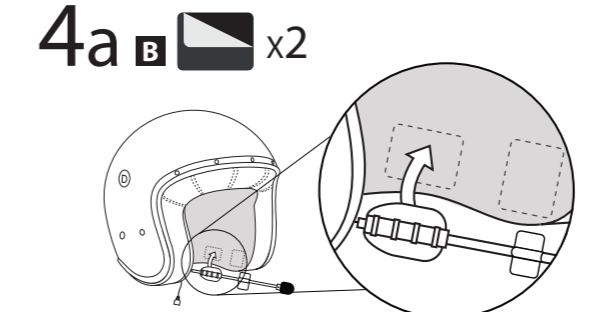

Place the mic to position the velcros
Platzieren Sie das Mikrofon, um die Klettverschlüsse zu positionieren
Placez le micro pour positionner les velcros
Posizionare il microfono per collocare i velcro
Colocar el micrófono para poner los velcros
マジックテープを位置づける為にマイクを付ける
放置麦克风以固定魔术贴

4b **E**

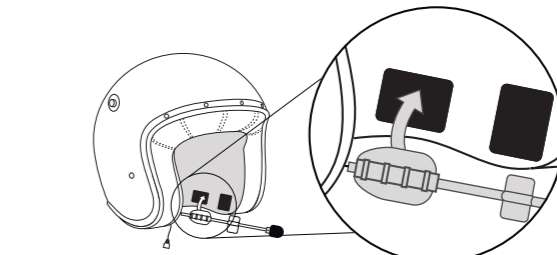

4c

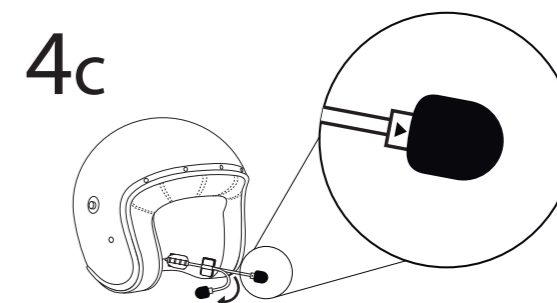

Arrow faces mouth
Pfeil zeigt zum Mund
La flèche doit faire face à la bouche
La freccia è rivolta verso la bocca
La flecha va a la boca
矢印が口に向かうように
箭头面向嘴部

Option 2

Full face helmet installation
Installation an Integralhelm
Installation sur casque intégral
Installazione su casco integrale
Instalación en el casco de cara completa
フルフェイスヘルメットへの取り付け
全面罩式头盔安装

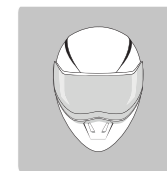

4* **D** **B** x2



4b* **D**

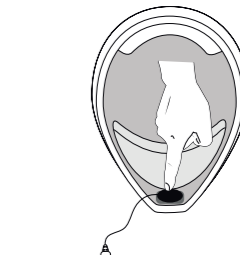

4c*

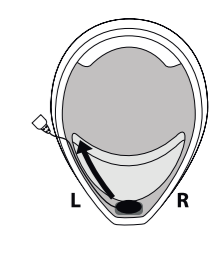

Measurements

front
90 mm

back
90 mm

145 mm

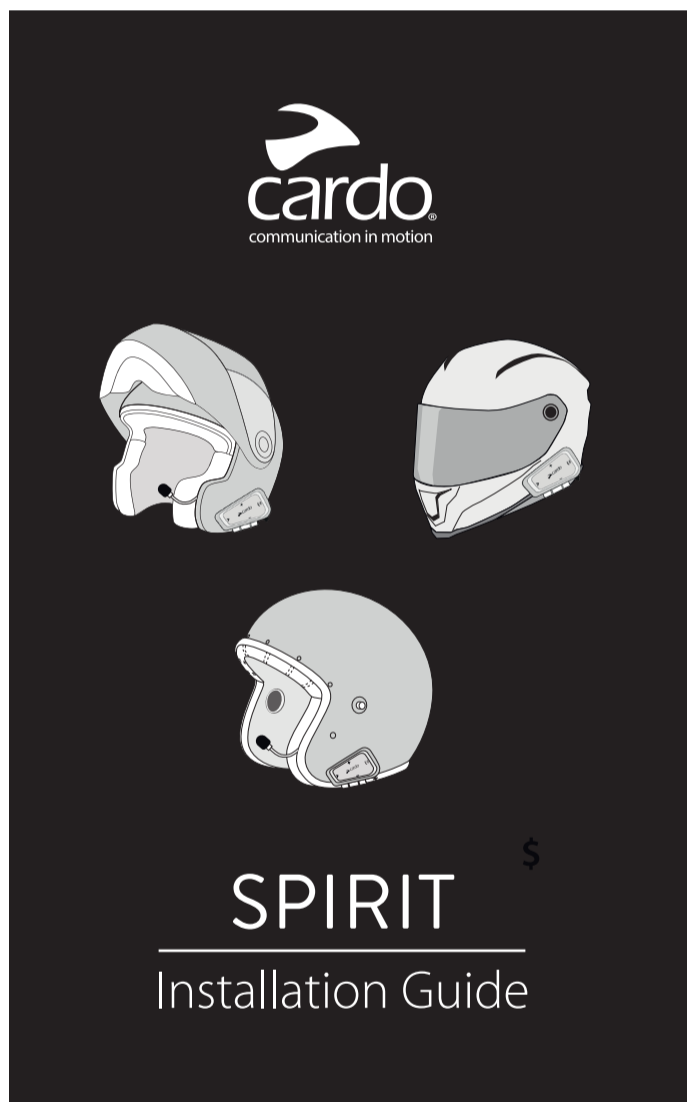

145 mm



TYPE APPROVAL

| | | | |
|-------------------------|--|------------|-------|
| P/N | MAN00572 | | |
| DESCRIPTION | INSTALLATION GUIDE | | |
| FILE NAME | MAN00572 - MAN INSTALLATION GUIDE SPIRIT_A03 | | |
| LANGUAGE | illustration | | |
| PRODUCT TYPE | MANUAL | | |
| MATERIAL | P2 C1+1 80 gr offset folded | | |
| PRINTING PROCESS | COLOR: BLACK / GRAY SCALE | | |
| SECONDARY PROCESS | | | |
| ATTACHED FILES | 1. GRAPHIC FILE - PDF 2. FOLLING INSTACTION VIDEO | | |
| MEASUREMENT | SPREAD: 145MM-720MM , FOLDED: 145MM-90MM | | |
| CLIENTS/ DISTRIBUTOR | | | |
| SPECIAL REQUIREMENT | | | |
| REVISION | DESCRIPTION | DATE | NAME |
| A03 | first version | 24.06.2021 | Almog |

| Rev | Change Description | Date | Approved by |
|-----|---|------------|-------------|
| A01 | first version | 09.03.2021 | almog |
| A02 | change the contant | 02.06.2021 | almog |
| A03 | change qr code video + adding spirit hd logo on front | 24.06.2021 | katy |